



Date		Type	
Project			
Location			
Model#		Quantity	
Specifier			

VERTIGO 140CM

DESIGNER : CONSTANCE GUISETT

YEAR : 2010

2 YEARS WARRANTY

MATERIAL : POLYURETHANE, FIBERGLASS, STEEL

Edited by Petite Friture in 2010, the Vertigo pendant light is now an icon of contemporary design. With its ultra-light fiber glass structure, stretched with velvety polyurethane ribbons, this pendant lamp fascinates as it comes to life

swaying in the soft air currents that surround it. Vertigo is, in the words of its designer, a "den lamp". It is simultaneously ethereal and graphic, adapting to both large and small spaces where it creates its own intimate space.

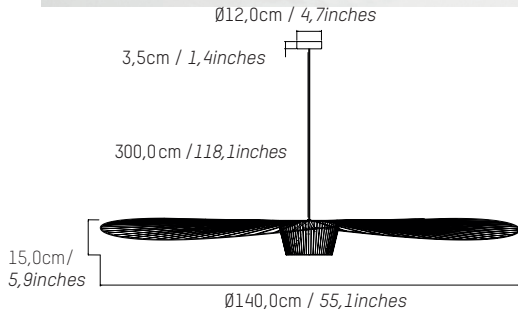



MAIN SPECIFICATIONS

COLOUR EAN REFERENCE

 Black
3760236180071
L0020301

 Green
3760236180088
L0020302

 Copper
3760236180095
L0020304

 White
3760236180101
L0020305

 Cobalt
3701128106687
L0020309

 Beetle
3701128106694
L0020310

 Bronze
3701128117928
L0020311

 Neon yellow
3701128122113
L0020312

PHYSICAL

MEASURES

Diameter 140,0cm / 55,1inches

Height 15,0cm / 5,9inches

Weight 0,5kg / 1,0lbs

PARCEL LOGISTICS

Box 1/1 73,0 x 73,0 x 21,0cm
28,7 x 28,7 x 8,3inches
2,5kg
5,5lbs

ELECTRICAL

Source type	Bulb	Replaceable source	Yes
Socket	E27	Power	60W max
Bulb advice	LED, G80, transparent with filaments	Cable lenght	300,0cm / 118,1inches
Environment	Indoor	Cable colour	Black (white for white)
Canopy included	Yes	Canopy shape	Circular
Canopy size	Ø12,0 x H3,5cm Ø4,7 x H1,4inches	Canopy material	Steel
Canopy colour	Black (white for white)	Light source	Not included
Dimmable	Yes, with a dimmable bulb	Switch	No
Category	Pendant lamp	Frequency	50-60Hz
Volt	220-240V~		



SPARE PARTS Electrical system, shade

ACCESSORIES 10m / 393,7inches cable